

STUDIO SERIES

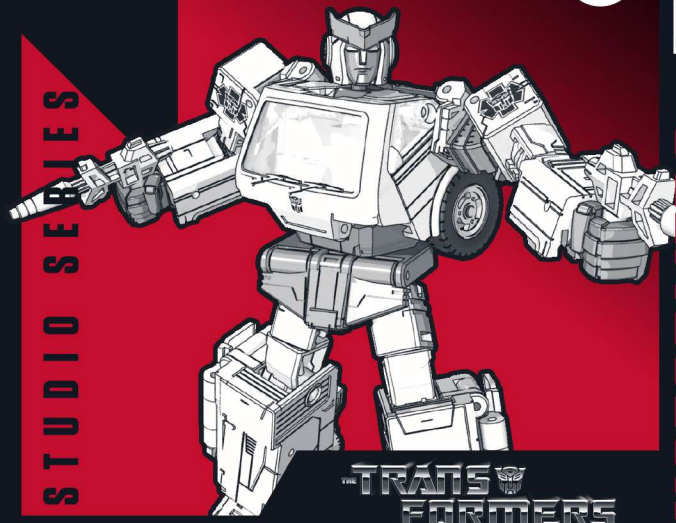

AUTOBOT RATCHET

※写真・イラストは実際の商品と異なる場合があります。

8+



TRANSFORMERS

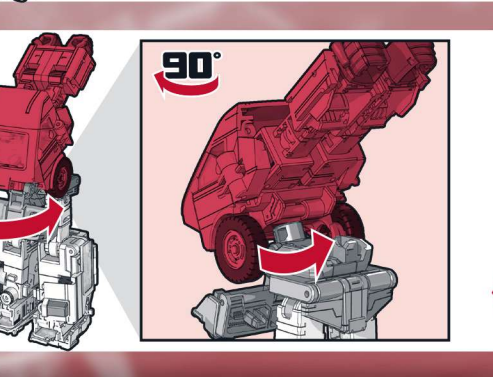
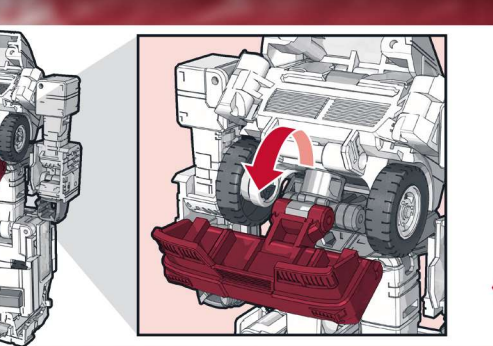
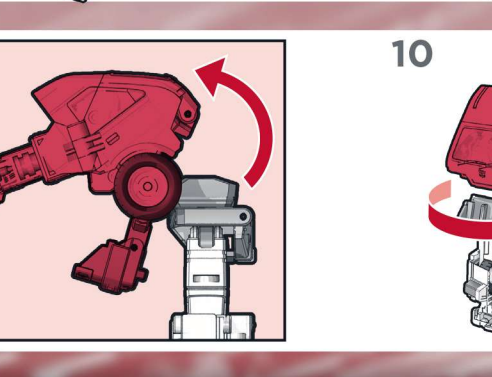
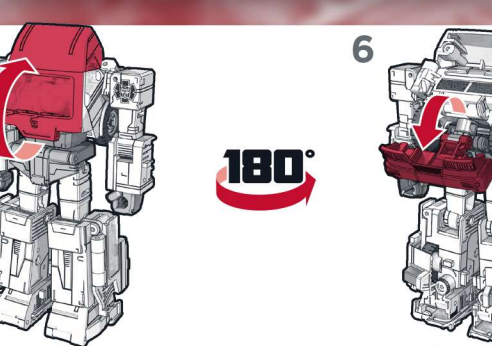
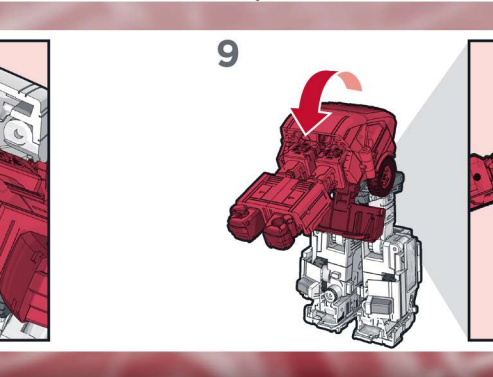
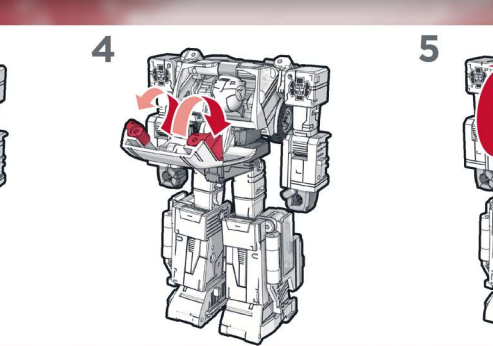
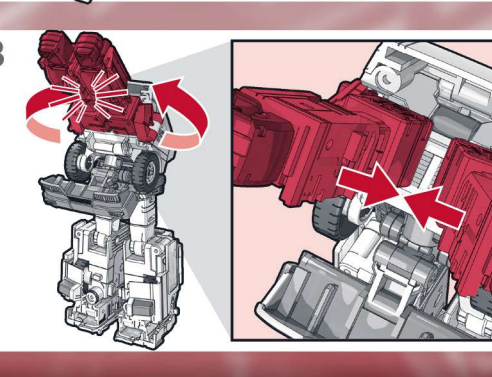
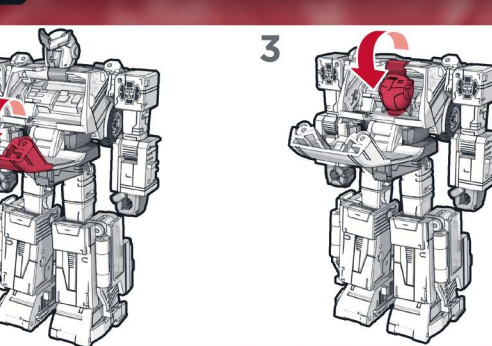
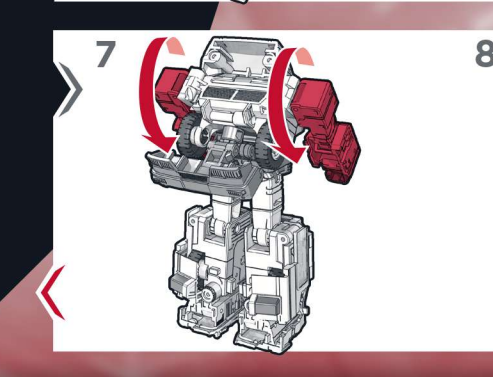
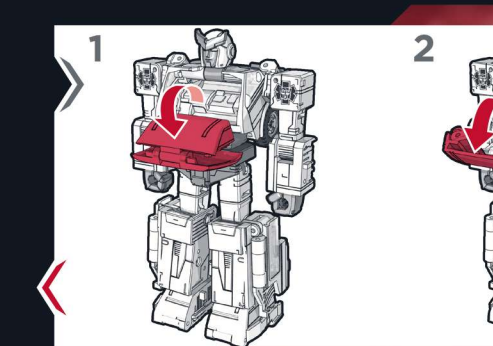
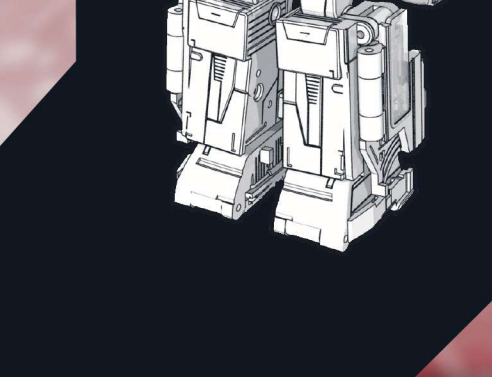
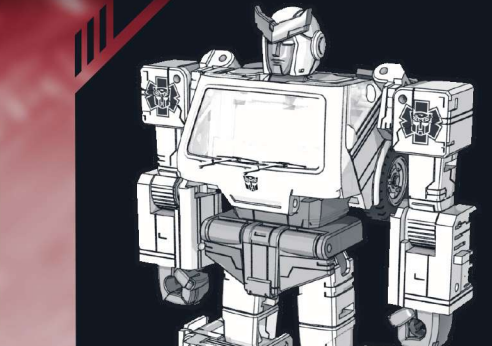
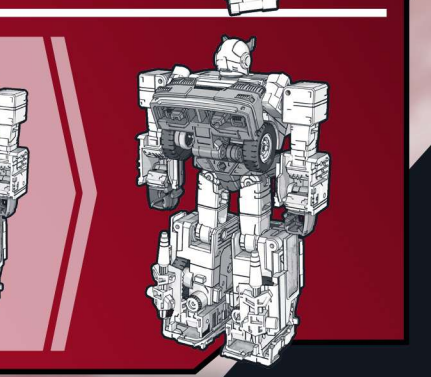
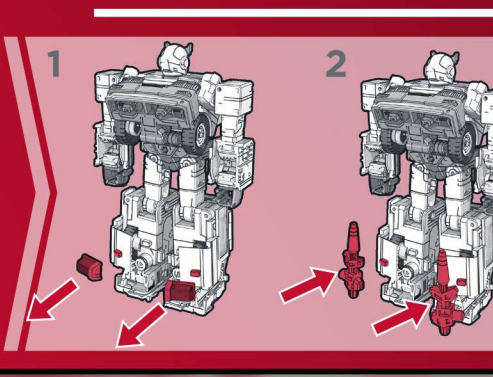
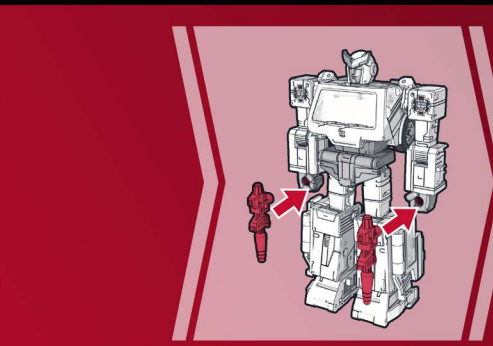
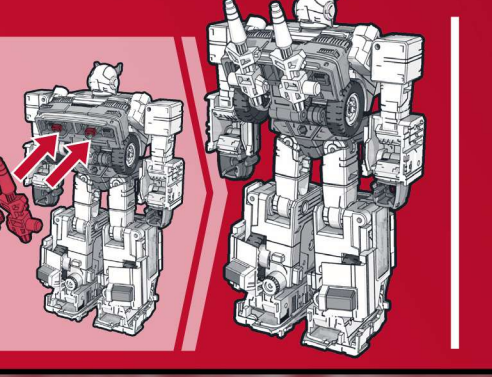
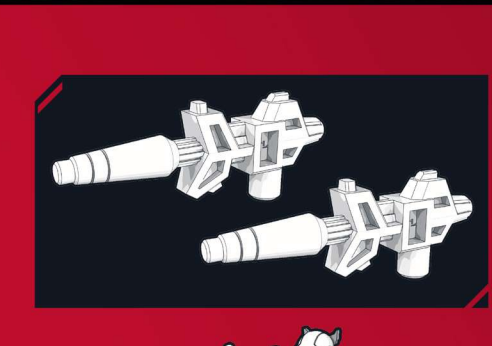

(en) Retain instructions for future reference. (fr) Conservez ces instructions pour référence ultérieure. (de) Bitte die Anleitung für spätere Rückfragen aufbewahren. (es) Conserve estas instrucciones para futuras referencias. (pt) Guardar instruções para eventuais consultas. (it) Conserva le istruzioni come futuro riferimento. (nl) Bewaar de gebruiksaanwijzing om later nog eens te lezen. (sv) Spara instruktionerna för att kunna hänvisa till dem i framtiden. (da) Gem vejledningerne til fremtidig referencebrug. (no) Ta vare på disse instruksjonene for fremtidig referanse. (fi) Säilytä nämä tiedot tulevaa tarvetta varten. (el) Φυλάξτε τις οδηγίες για μελλοντική αναφορά. (pl) Zachowaj instrukcje na przyszłość. (hu) Őrizd meg a használati útmutatót. (tr) İleride başvurmak üzere talimatları saklayın. (cy) Iyto informace uschovajte pro budoucí použití. (cs) Návod si odložte na použití v budoucnosti. (sk) Pástrează instrucțiunile pentru a le consulta în viitor. (bg) Запазете инструкциите за бъдещи справки. (hr) Sačuvajte upute za buduću upotrebu. (ru) Инструкции пасликіце ацеіцаі. (sl) Navodila shrani, mogoče jih boš še potreboval. (uk) Збережіть інструкції для подальшого використання. (lv) Ķata juhised edasiseks kasutamiseks alles. (lv) Saglabājiet instrukciju atsaucēi. (ar) احتفظ بالتعليمات للرجوع إليها في المستقبل.

Manufactured under license from TOMY Company, Ltd. TAKARATOMY logo is property of Tomy Company, Ltd. TRANSFORMERS and HASBRO and all related trademarks and logos are trademarks of Hasbro, Inc. © 2023 Hasbro. Hasbro, Pawtucket, RI 02861-1059 USA. HASBRO CANADA, LONGUEUIL, QC, CANADA J4G 1G2. US/CANADA TEL. 1-800-255-5516. Importado por: HASBRO DE MÉXICO, S. DE R.L. DE C.V. Boulevard Manuel Ávila Camacho #32, piso 3, Colonia Lomas de Chapultepec I Sección, Alcaldía Miguel Hidalgo, C.P. 11000, Ciudad de México, México. Centro de Servicio para México: TEL. 5876-2998 y para el interior de la República TEL. 01-800-7-12-62-25. Manufactured by/Produced by: Hasbro SA, Rue Emile-Boéchat 31, 2800 Delémont, CH. Represented by/Reprezentat de: Hasbro, De Entree 240, 1101 EE Amsterdam, NL. (en) Hasbro UK Ltd., P.O. Box 43, Newport, NP19 4YH, UK. (tr) Üretici Firma Bilgileri: Hasbro SA, Rue Emile-Boéchat 31, 2800 Delémont Isviçre TEL +41 324210800. Hasbro Oyuncak San. ve Tic. A.Ş. tarafından ithal edilmiştir. Tüketici Hizmetleri: Burhaniye Mah. Abdullahaga Cad. No: 51/2 34676 Beylerbeyi Istanbul Türkiye TEL +90 2164229010.



F7243/E0702 Asst. PN00084030

