

取扱説明書
対象年齢
15才以上

トランスフォーマー マルチメディア エンタテインメント
TRANSFORMERS LEGACY EVOLUTION
※本書をご確認後は、必ず保管しておいてください。

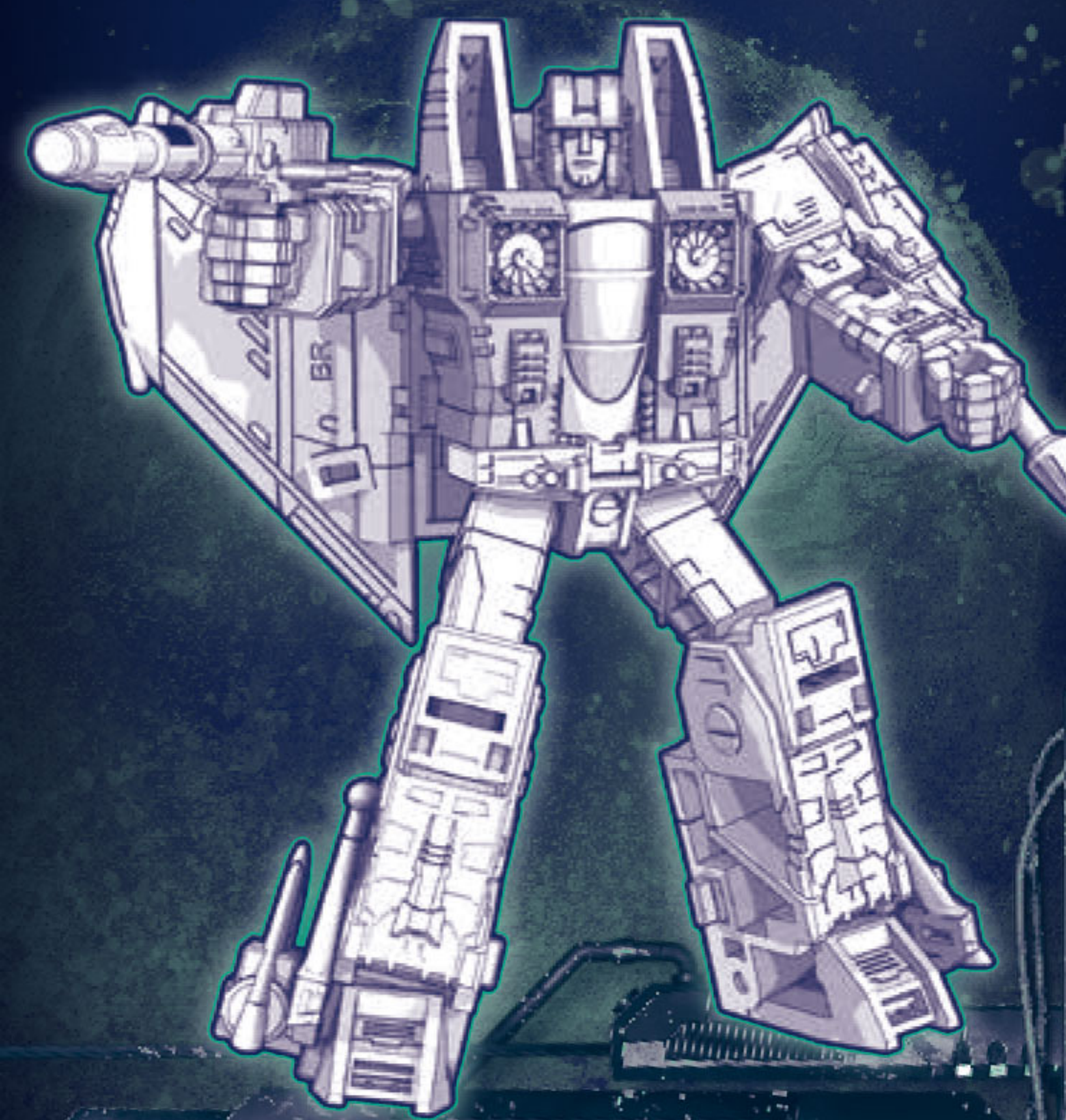

TRANSFORMERS

THUNDERCRACKER

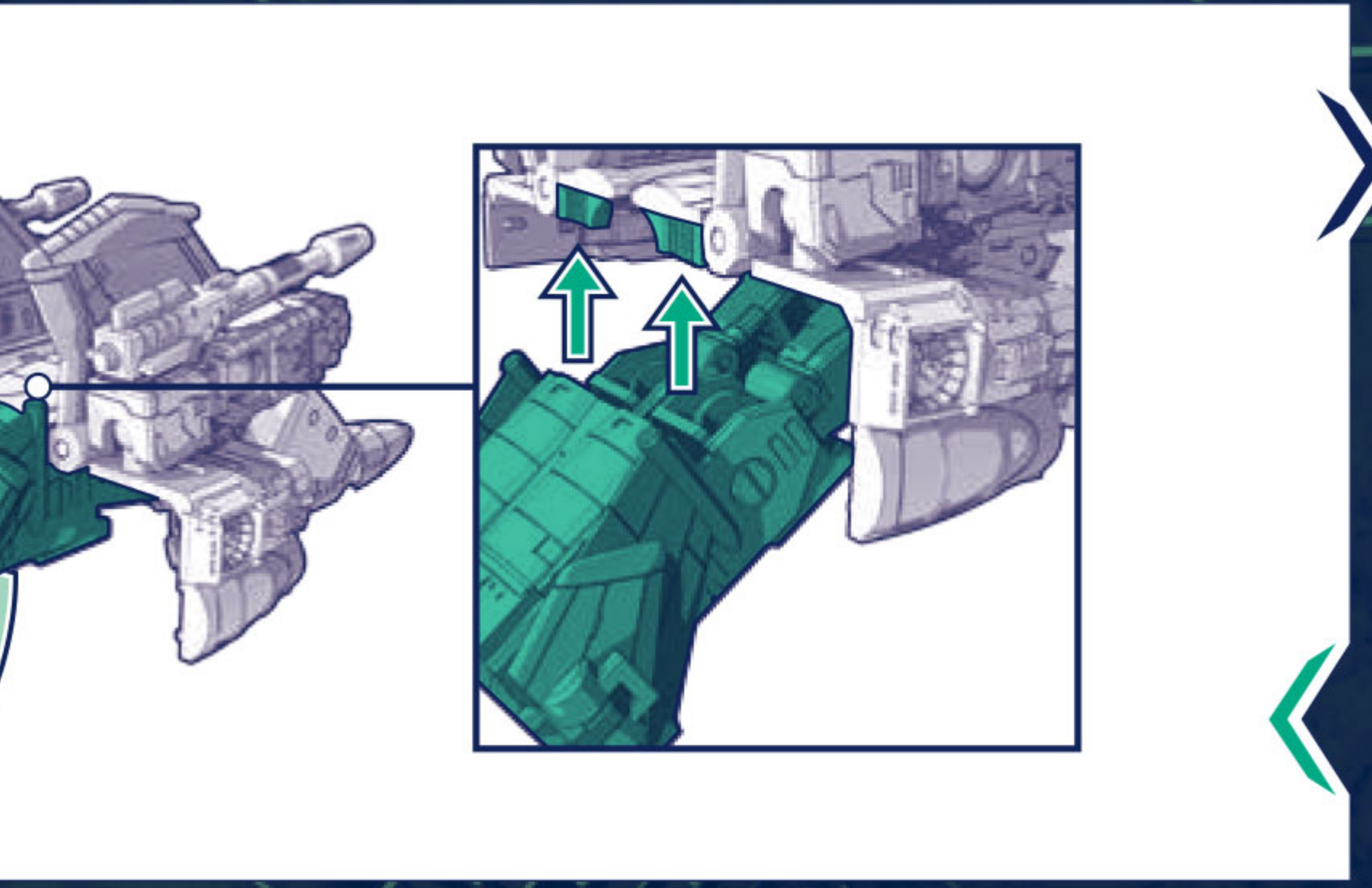
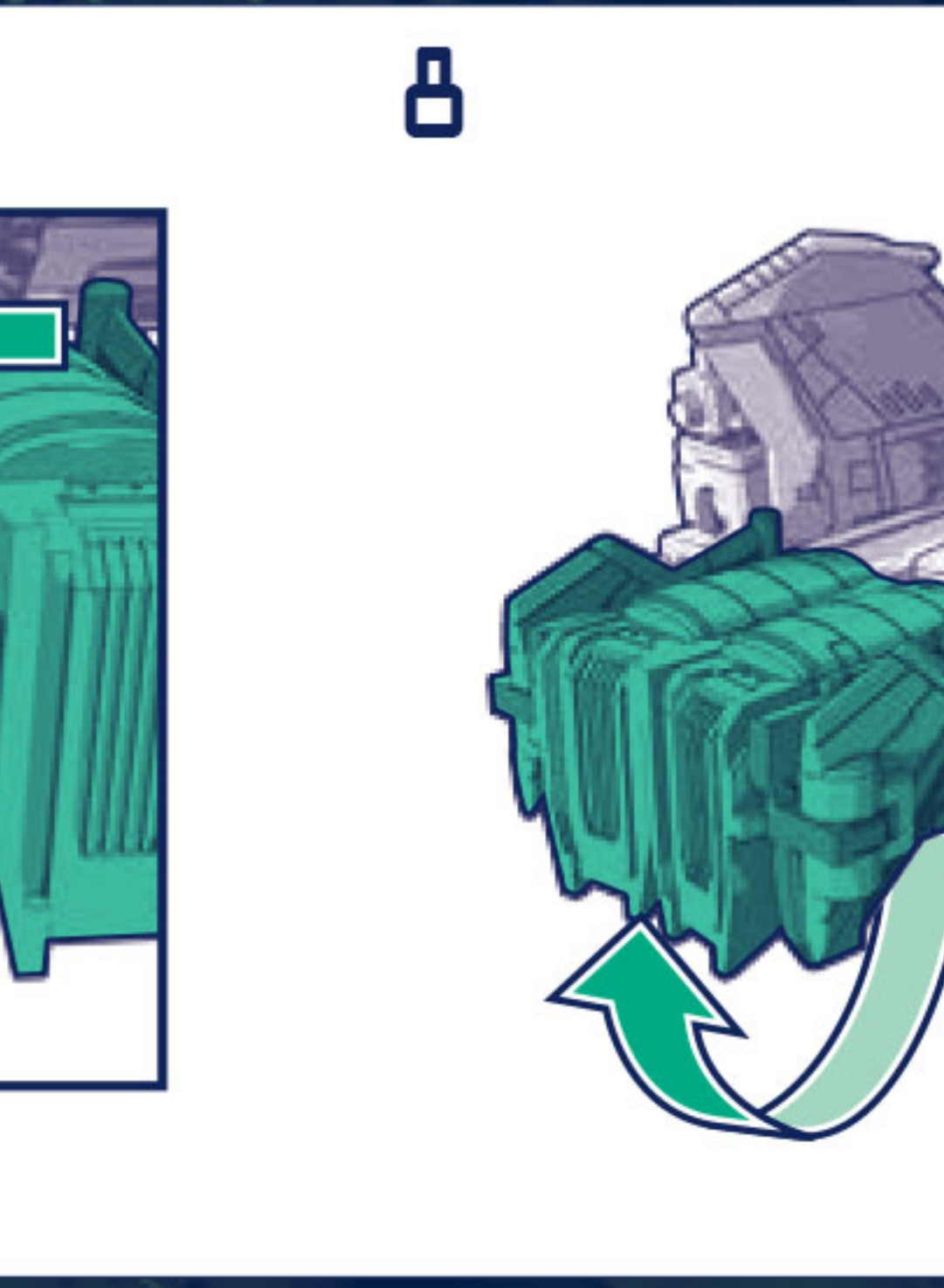
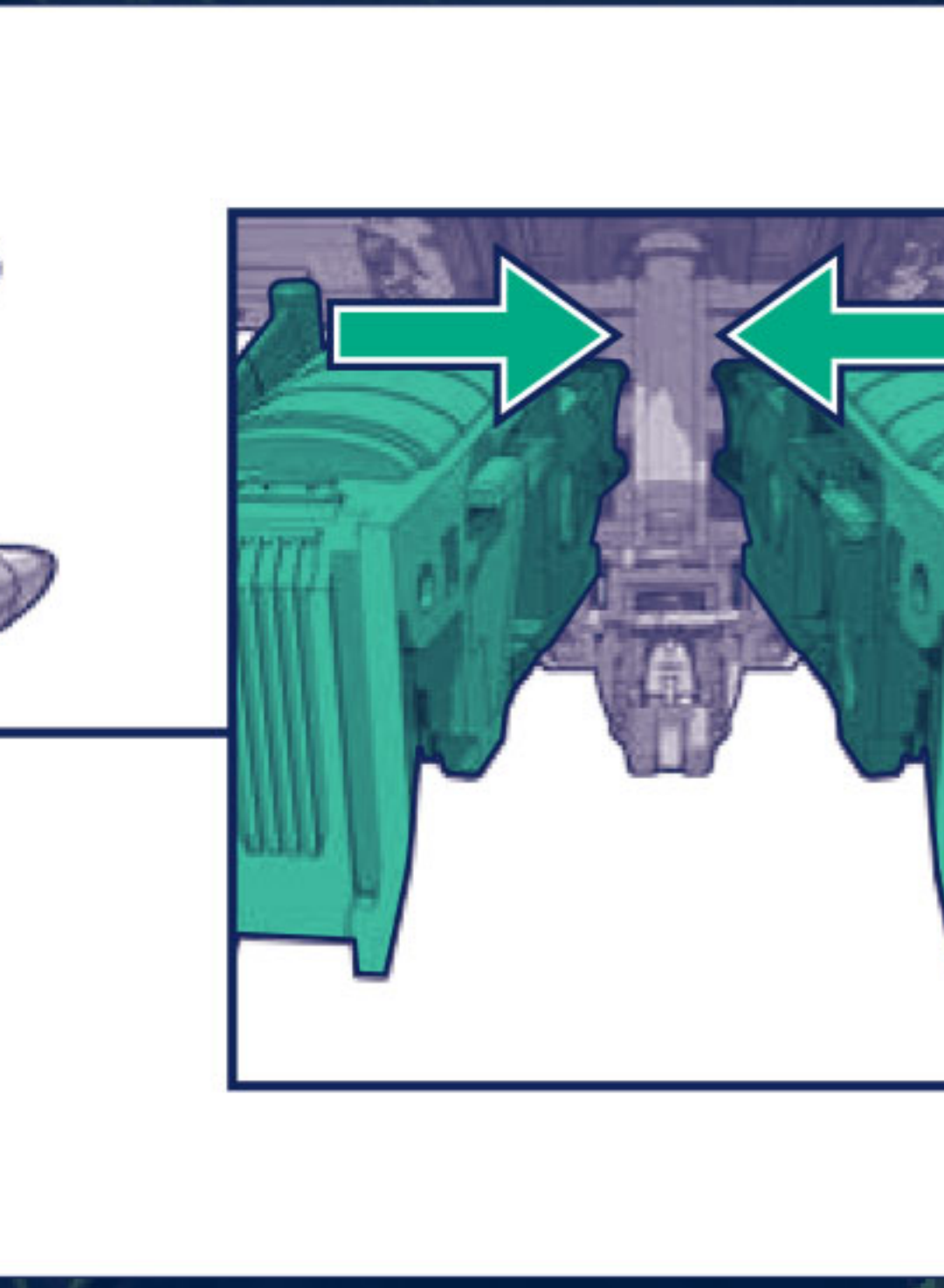
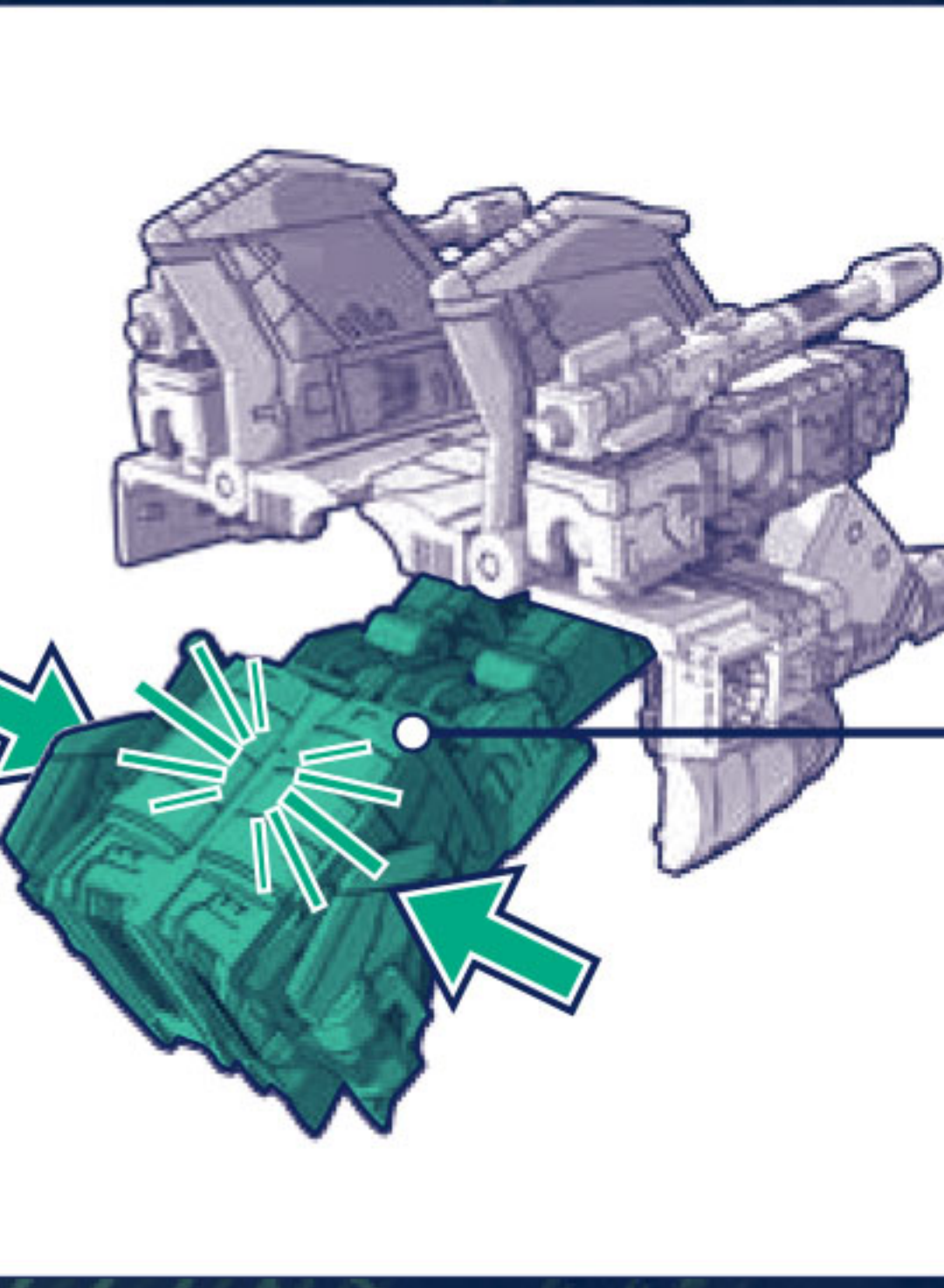
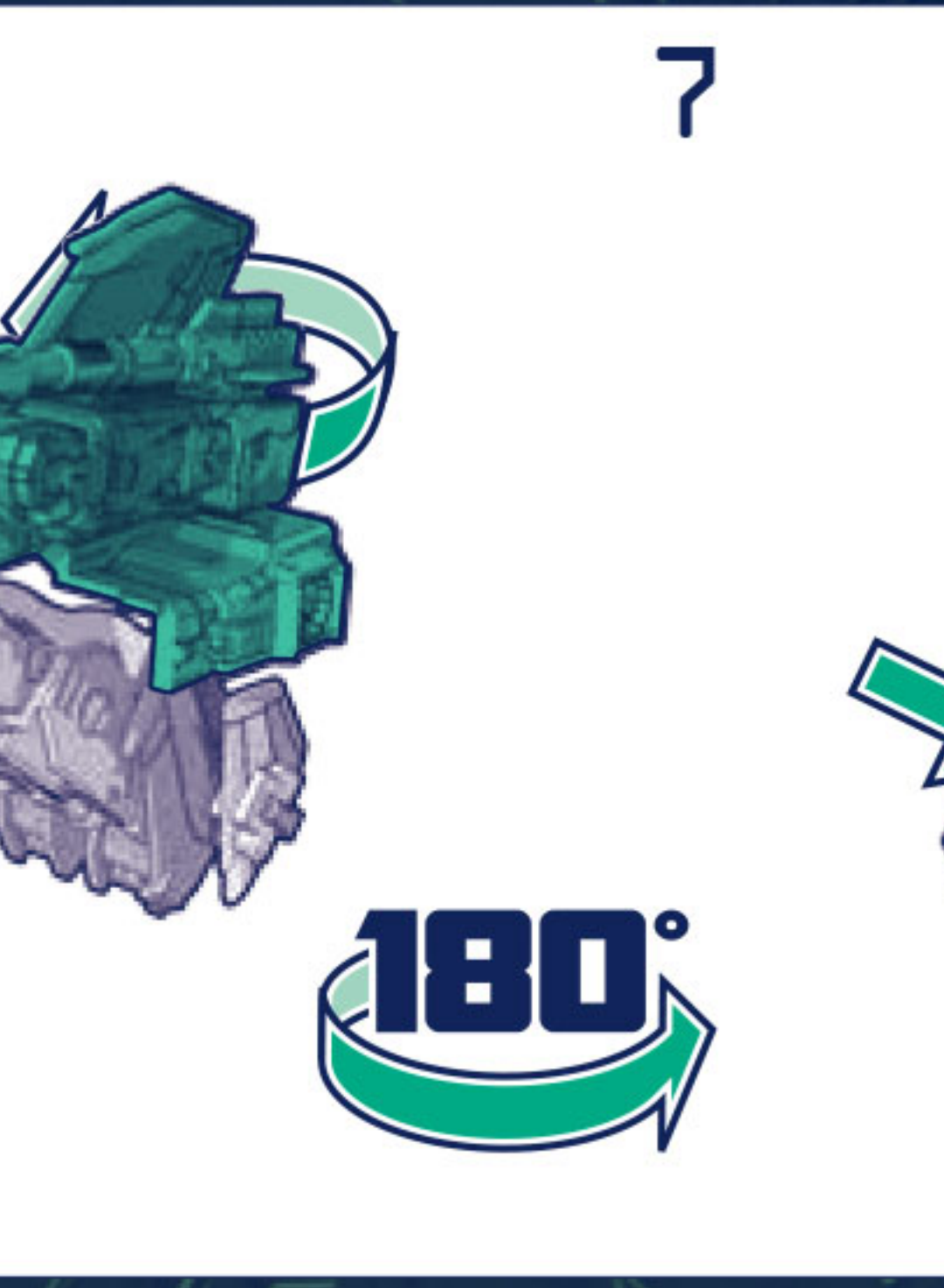
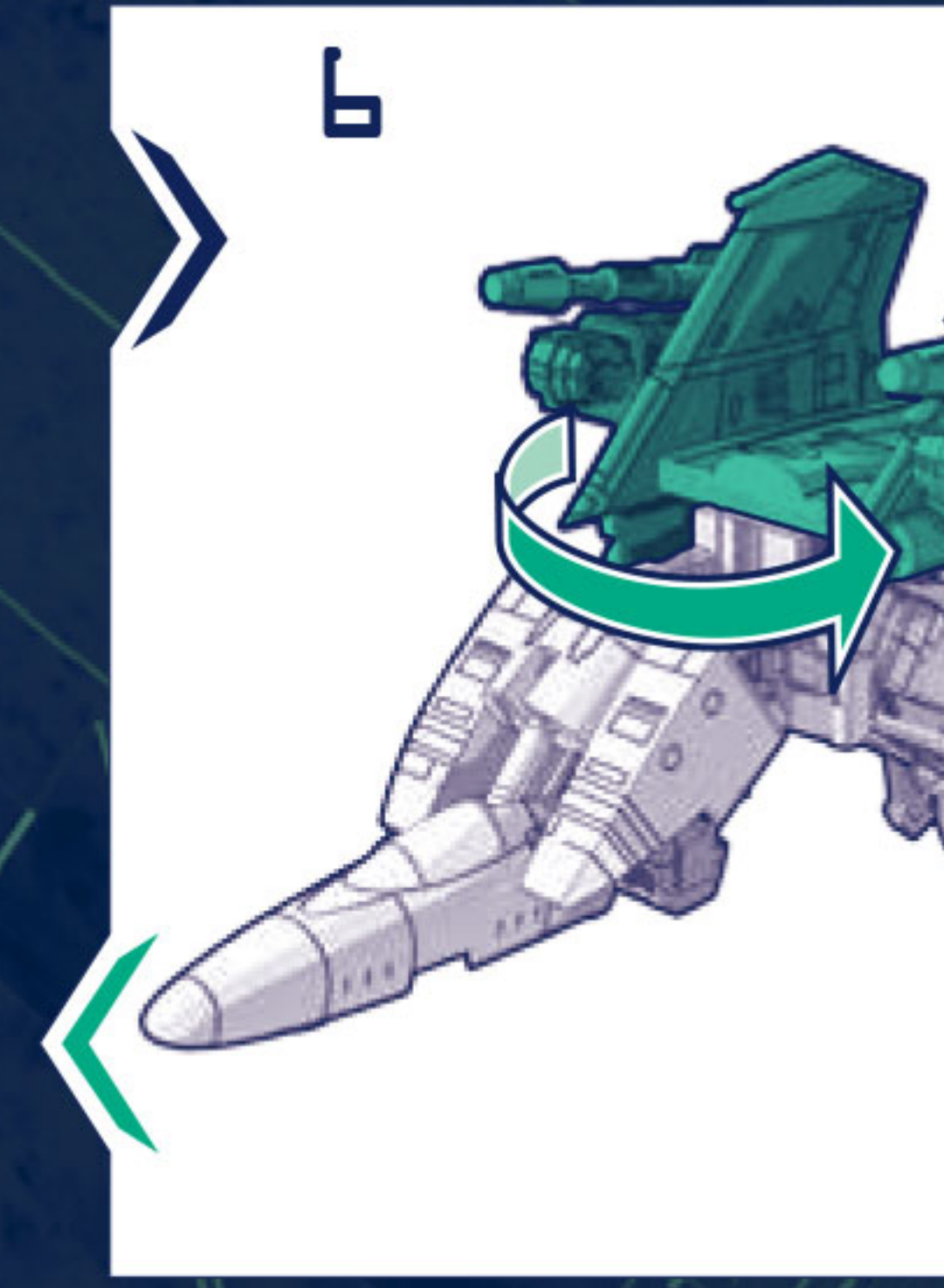
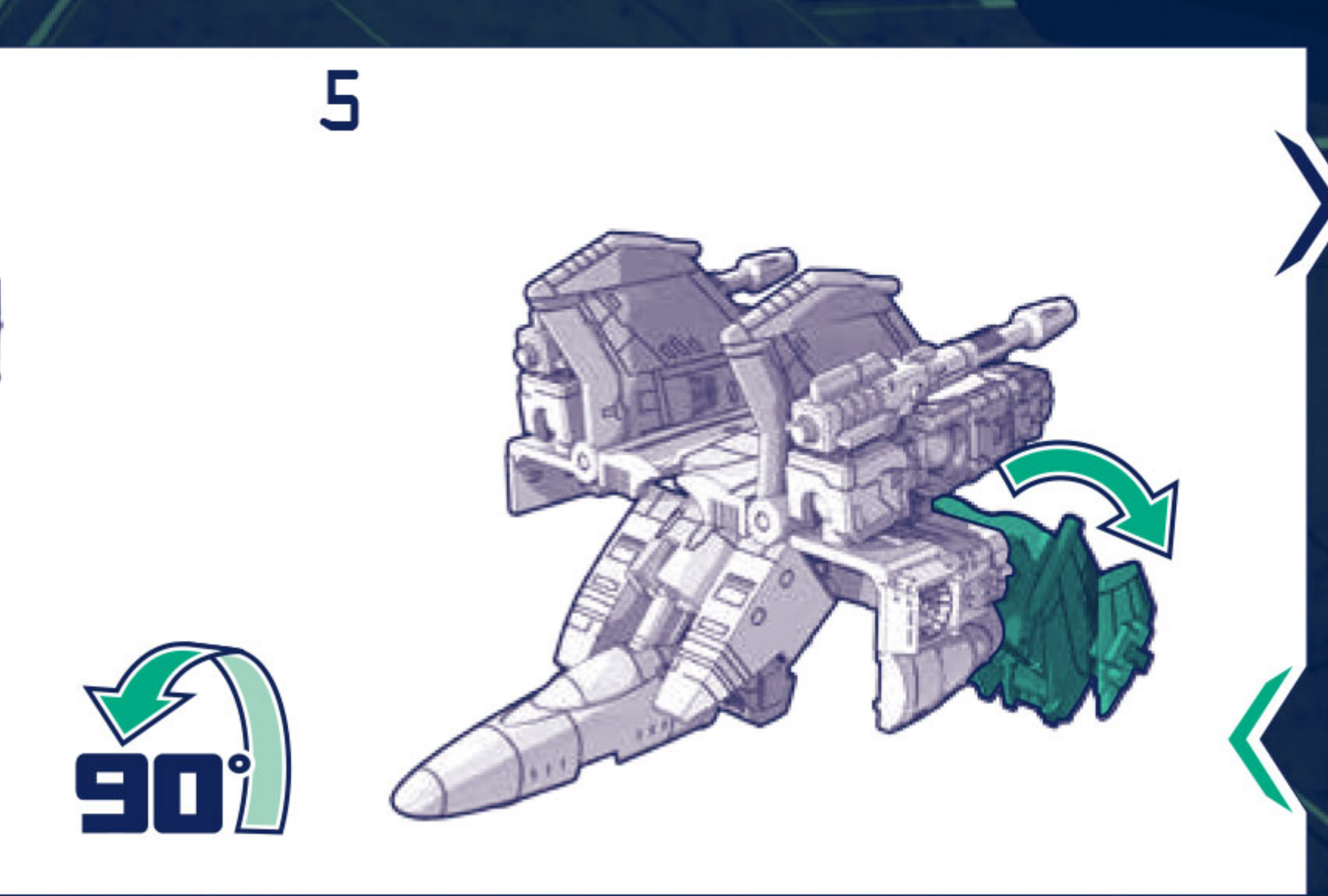
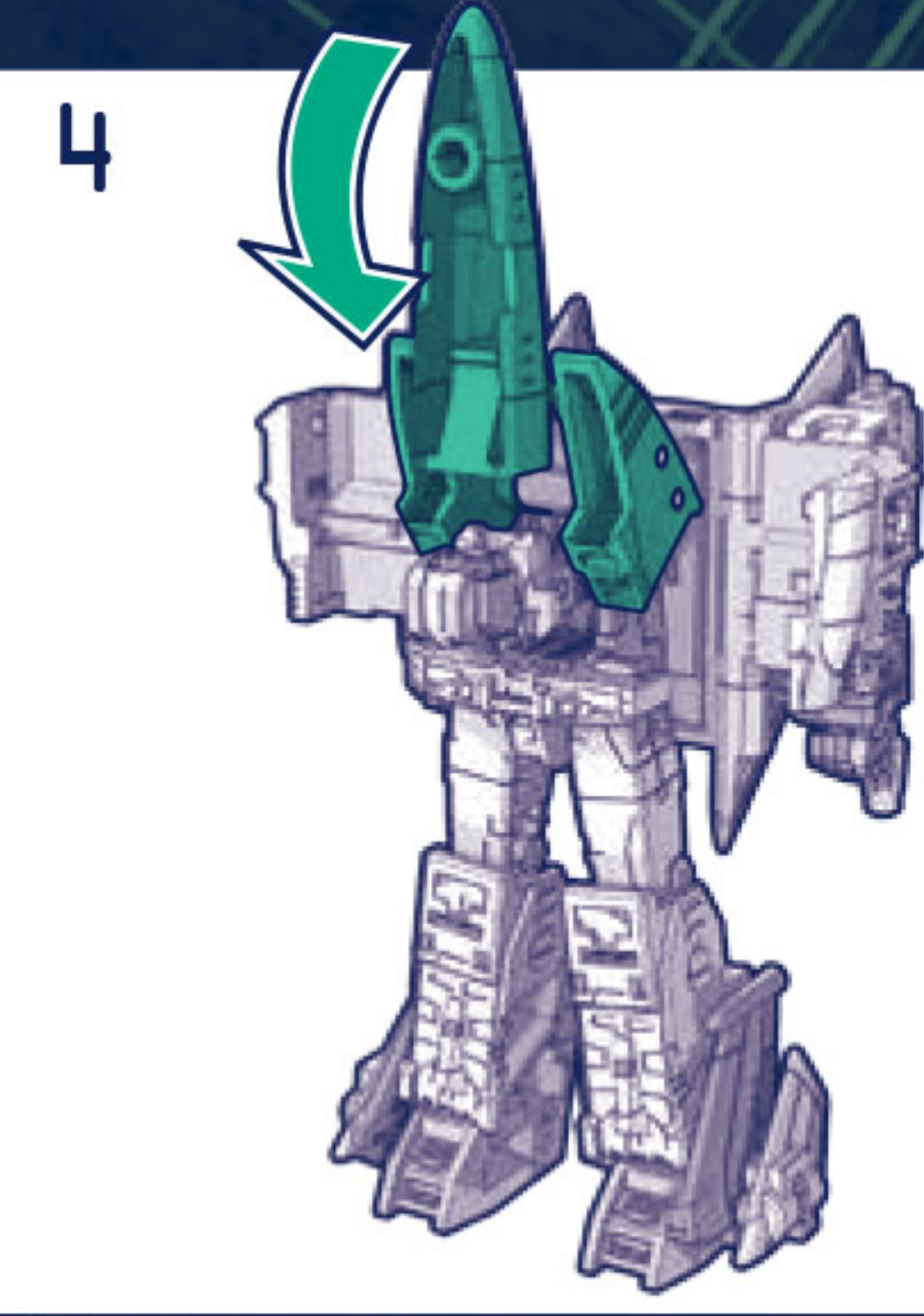
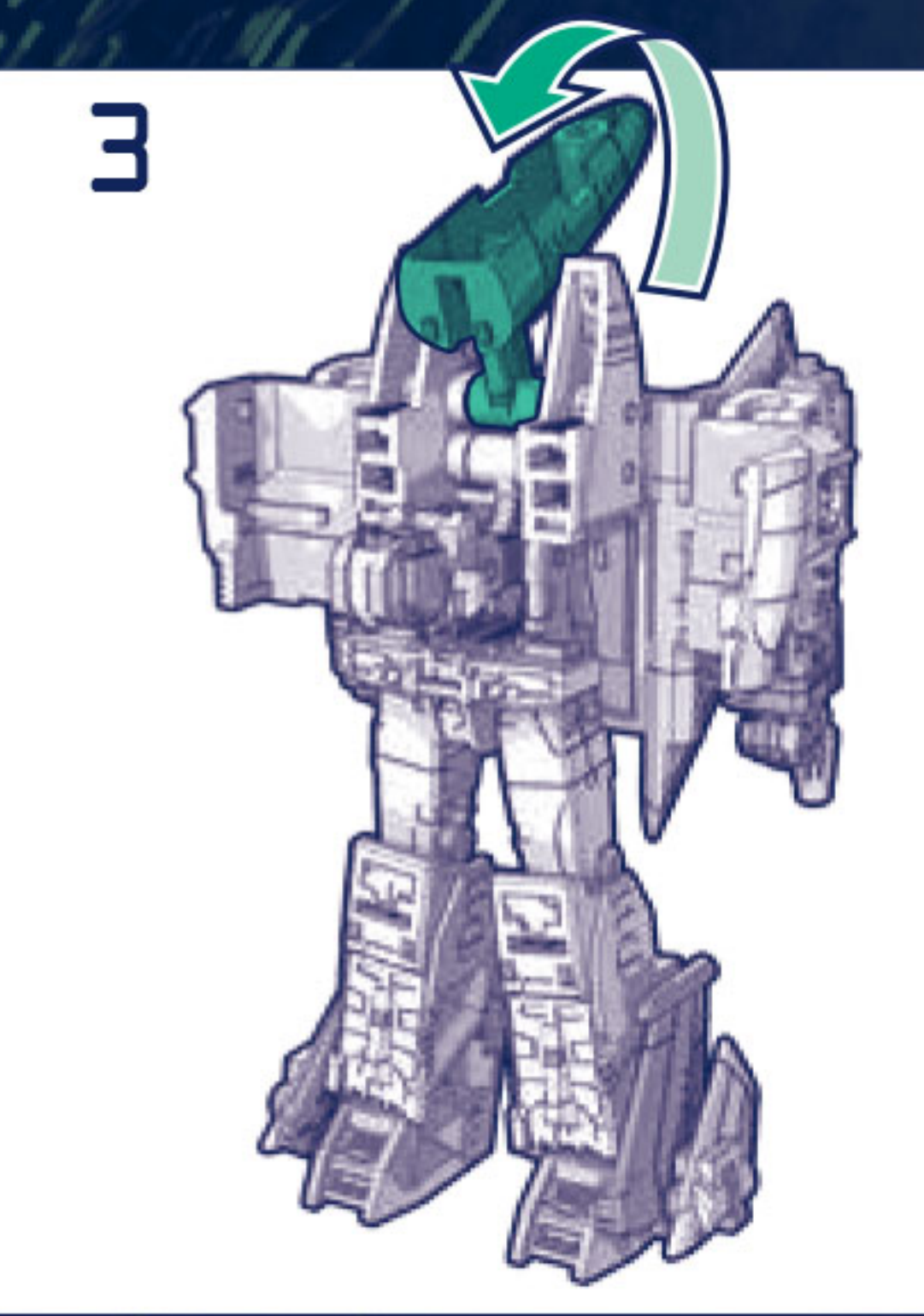
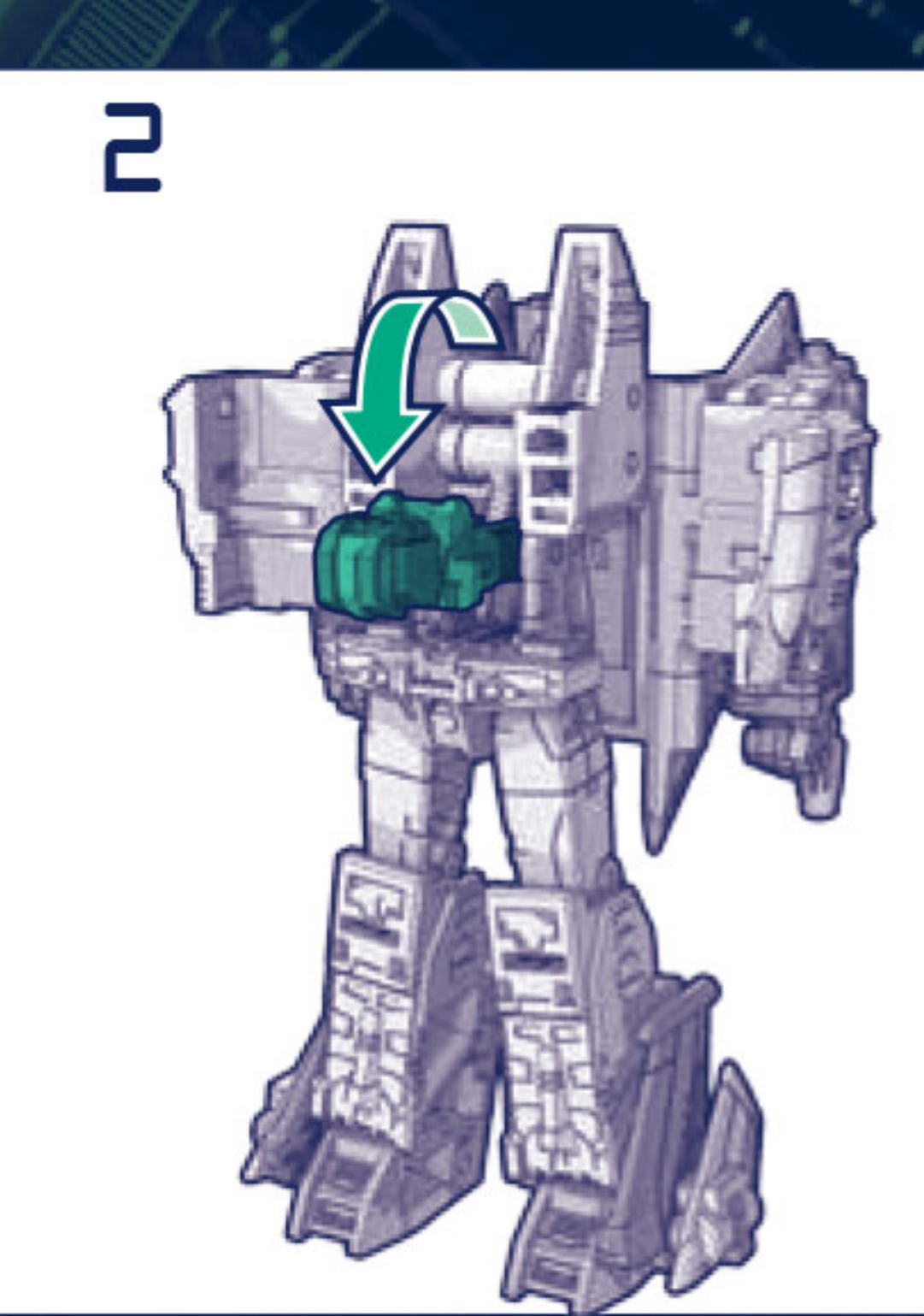
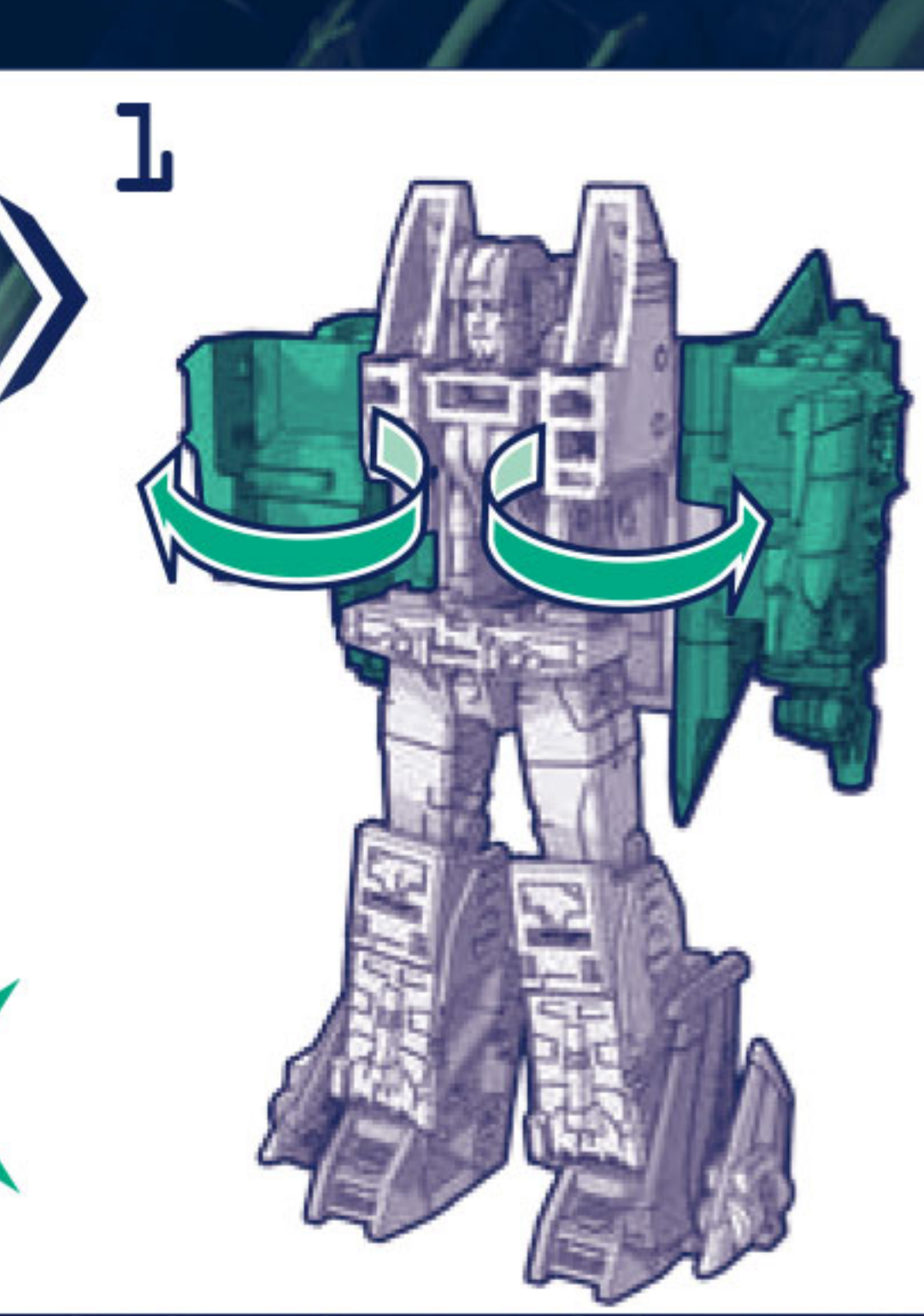
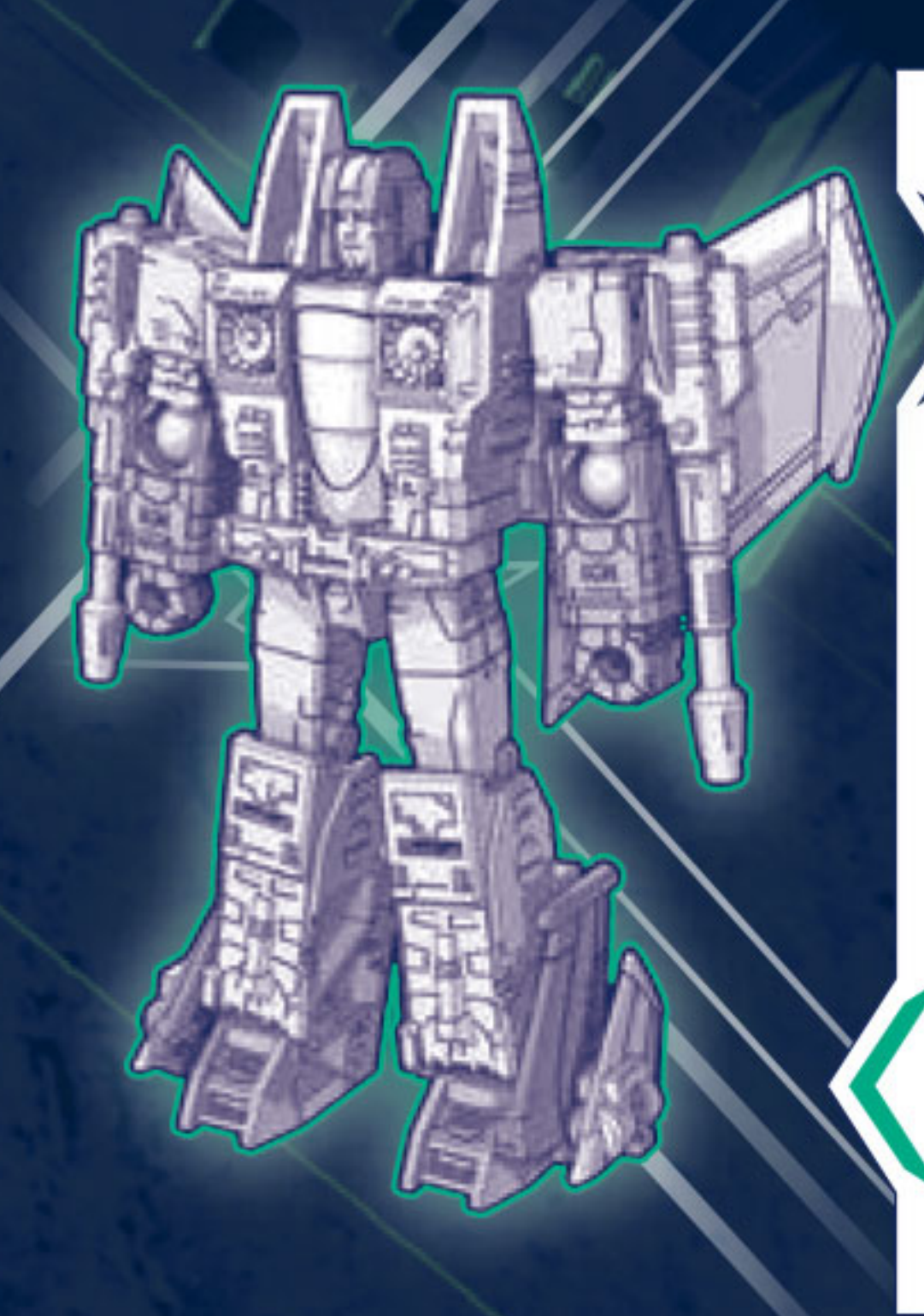
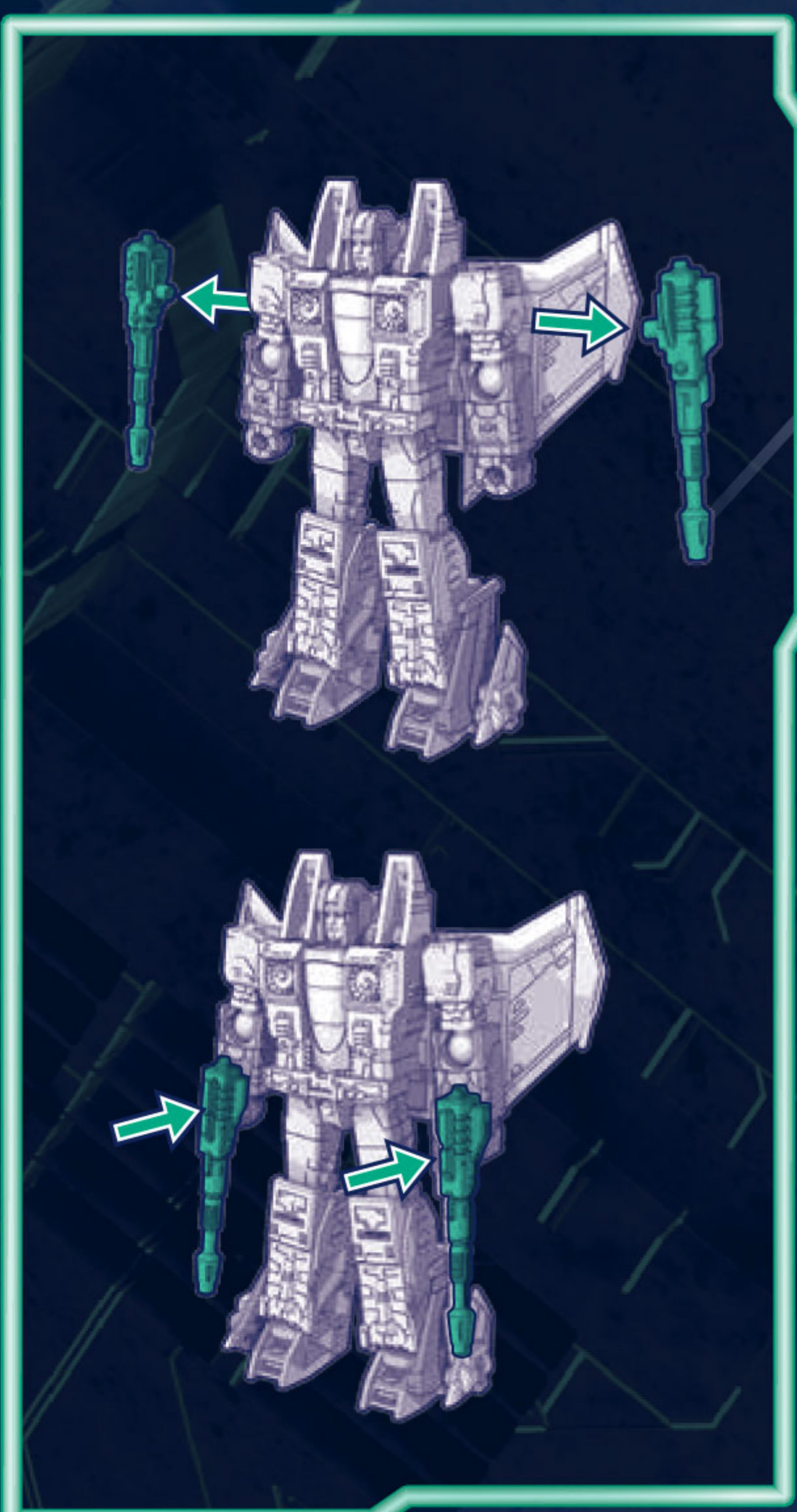

※写真・イラストは実際の商品と異なる場合があります。

en Parents:	fi Vanhemmat:	hr Roditelji:
fr Parents :	el Γονείς:	it Tèvai:
de Eltern:	pl Rodziców:	sl Starši:
es Padres:	hu Szülők:	uk Батьки:
pt Pais:	tr Ebeveynler:	et Lapsevanemad:
it Genitori:	es Rodiçe:	lv Vecāki:
nl Ouders:	sk Rodičia:	الآباء ar
sv Föräldrar:	ro Părinți:	
da Forældre:	ru Родители:	
no Foreldre:	bg Родителите:	

en Retain instructions for future reference. fr Conservez ces instructions pour référence ultérieure. de Bitte die Anleitung für spätere Rückfragen aufbewahren. es Conserve este instructivo para futuras referencias. pt Guardar instruções para eventuais consultas. it Conserva le istruzioni come futuro riferimento. nl Bewaar de gebruiksaanwijzing om later nog eens te lezen. sv Spara instruktionerna för att kunna hänvisa till dem i framtiden. da Gem vejledninger til fremtidig referencebrug. no Ta vare på disse instruksjonene for fremtidig referanse. fi Säilytä nämä tiedot tulevaa tarvetta varten. el Φυλάξτε τις οδηγίες για μελλοντική αναφορά. pl Zachowaj instrukcje na przyszłość. hu Őrizd meg a használati útmutatót. tr İleride başvurmak üzere talimatları saklayın. es Tyto informace uschovejte pro budoucí použití. sk Návod si odložte na použitie v budúcnosti. ro Păstrează instrucțiunile pentru a le consulta în viitor. ru Сохраните инструкцию для будущего использования. bg Запазете инструкциите за бъдещи справки. hr Sačuvajte upute za buduću upotrebu. lt Instrukcija pasilikite ateičiai. sl Navodila shrani, mogoče jih boš še potreboval. uk Збережіть інструкції для подальшого використання. et Jäta juhised edasiseks kasutamiseks alles. lv Saglabāiet instrukciju atsaucēi. احتفظ بالتعليمات للرجوع إليها في المستقبل ar

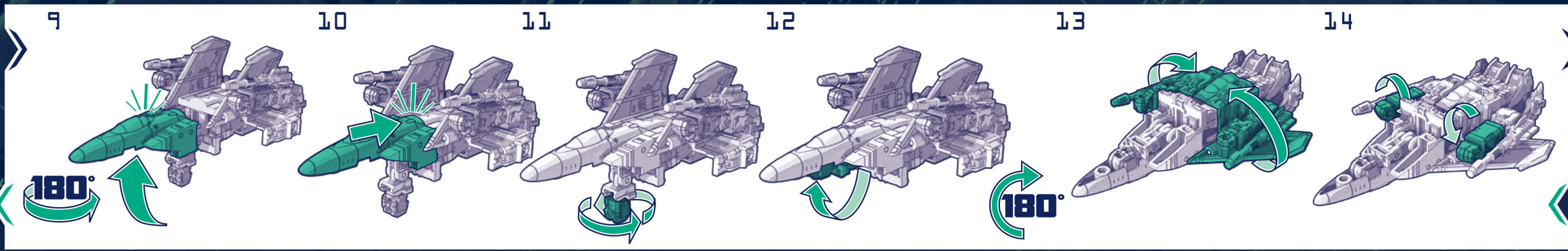

Manufactured under license from TOMY Company, Ltd. TAKARATOMY logo is property of Tomy Company, Ltd. TRANSFORMERS and HASBRO and all related trademarks and logos are trademarks of Hasbro, Inc. © 2023 Hasbro. Hasbro, Pawtucket, RI 02861-1059 USA. HASBRO CANADA, LONGUEUIL, QC, CANADA J4G 1G2. US/CANADA TEL. 1-800-255-5516. Importado por: HASBRO DE MÉXICO, S. DE R.L. DE C.V. Boulevard Manuel Ávila Camacho #32, piso 3, Colonia Lomas de Chapultepec I Sección, Alcaldía Miguel Hidalgo, C.P. 11000, Ciudad de México, México. Centro de Servicio para México: TEL. 5876-2998 y para el interior de la República TEL. 01-800-7-12-62-25. Manufactured by/Produs de: Hasbro SA, Rue Emile-Boéchat 31, 2800 Delémont, CH. Represented by/Reprezentat de: Hasbro, De Entree 240, 1101 EE Amsterdam, NL. © Hasbro UK Ltd., P.O. Box 43, Newport, NP19 4YH, UK. © Üretici Firma Bilgileri: Hasbro SA, Rue Emile-Boéchat 31, 2800 Delémont İsviçre TEL +41 324210800. Hasbro Oyuncak San. ve Tic. A.Ş. tarafından ithal edilmiştir. Tüketici Hizmetleri: Burhaniye Mah. Abdullahağa Cad. No: 51/2 34676 Beylerbeyi İstanbul Türkiye TEL +90 2164229010.

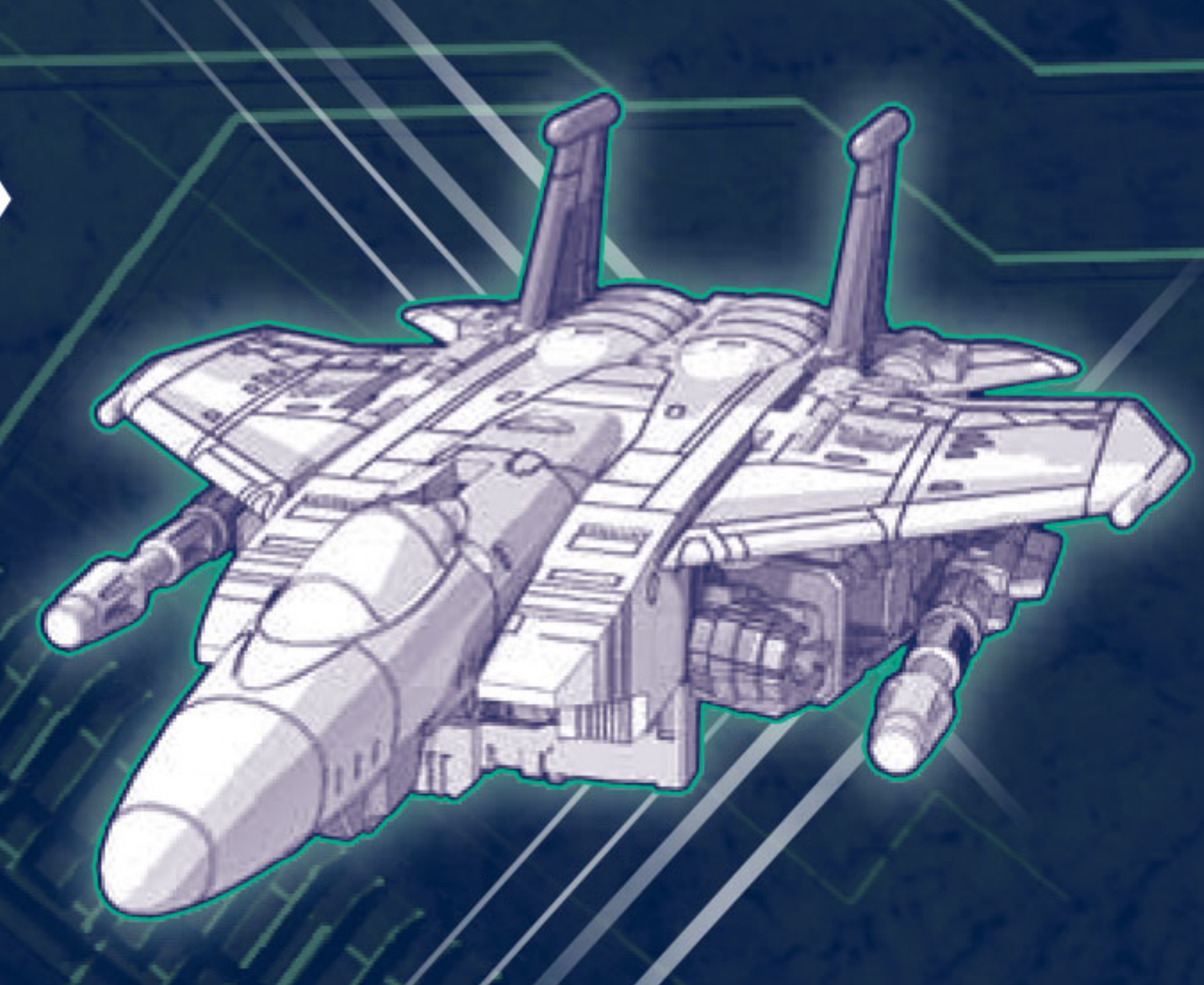
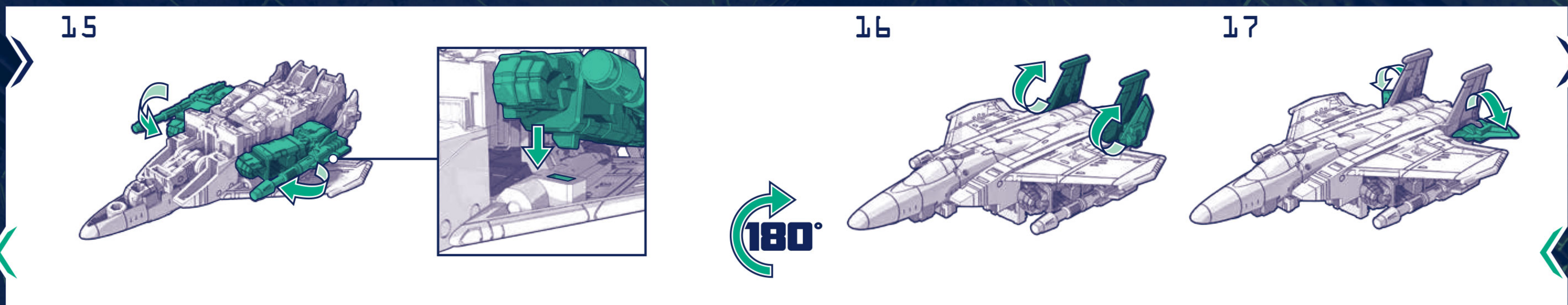

CE UK CA 22 PAP FR TAKARA TOMY Hasbro F7179/F2988 Asst. PN00080828