

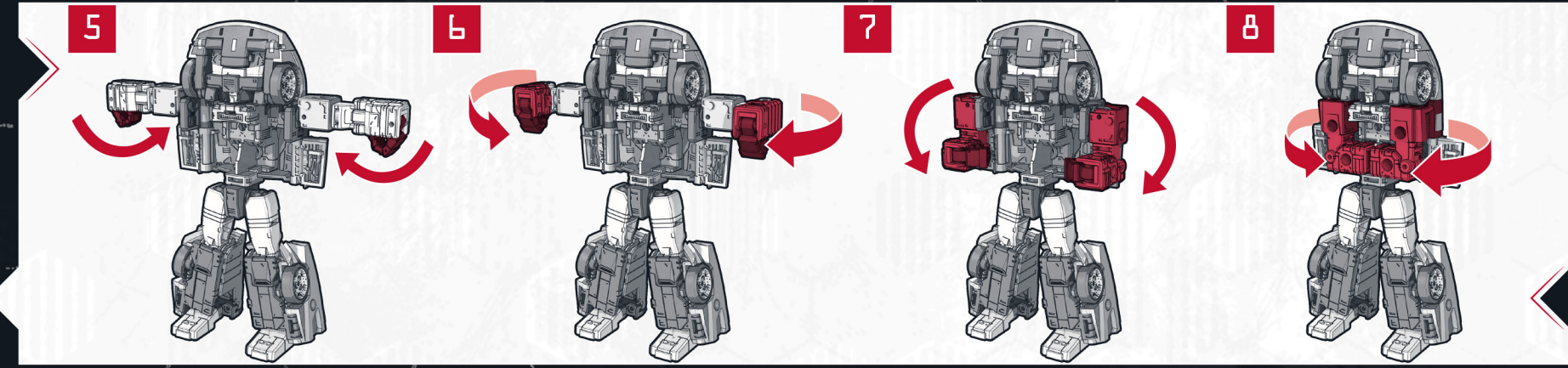

TRANSFORMERS

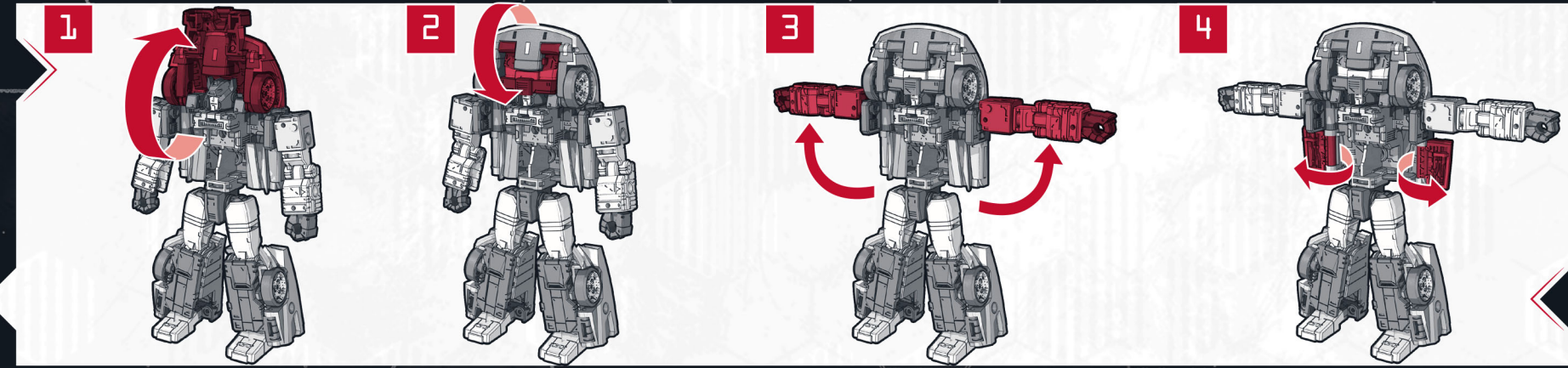

※写真、イラストは実際の商品と異なる場合があります。

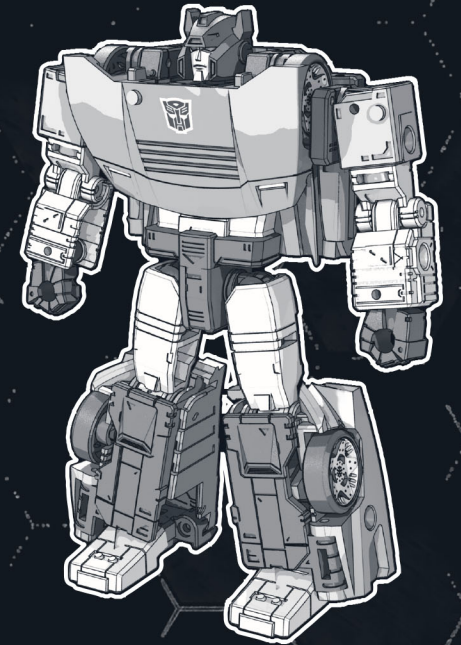
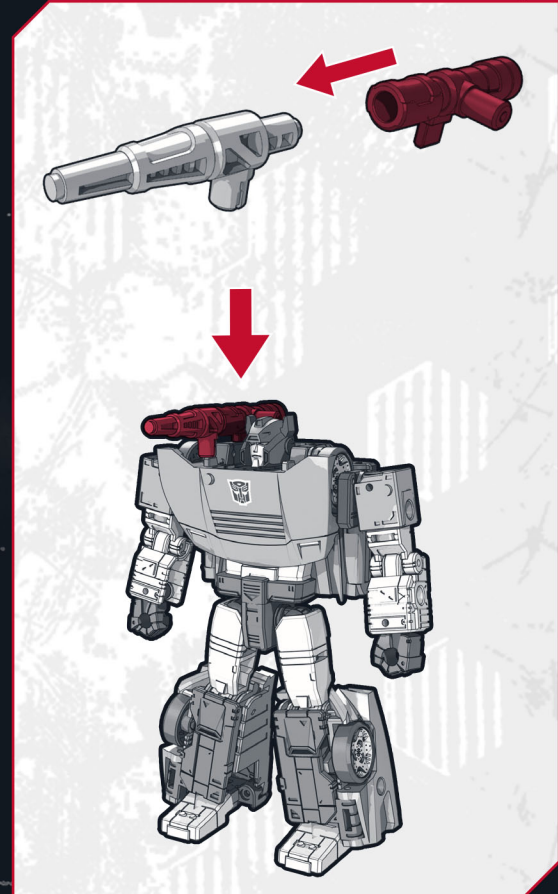
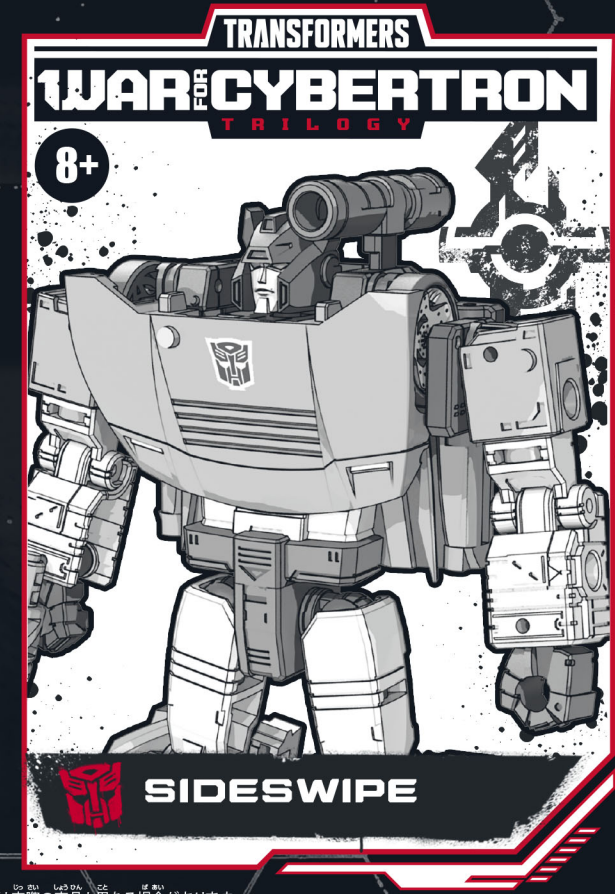

9

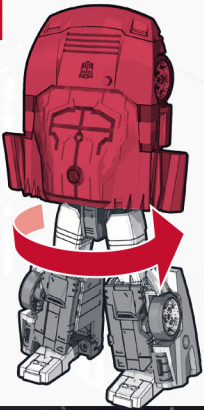

10

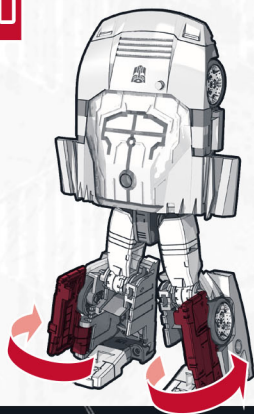

11

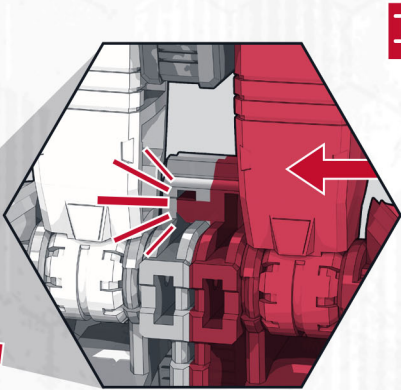
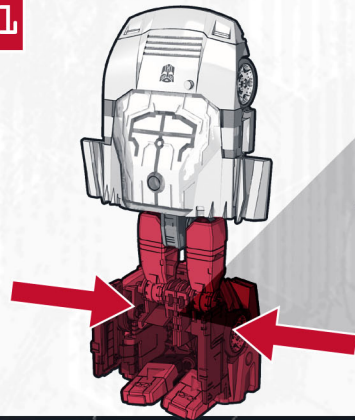

12

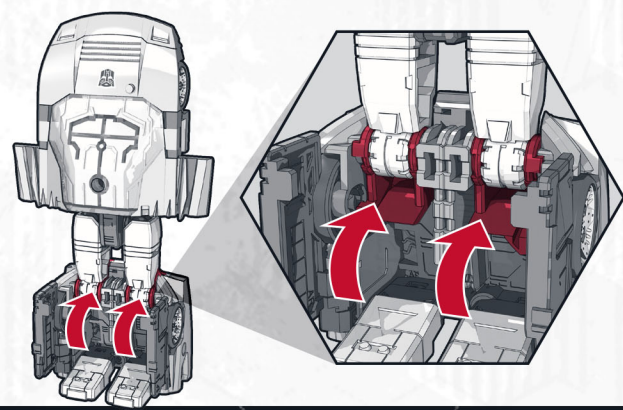

13

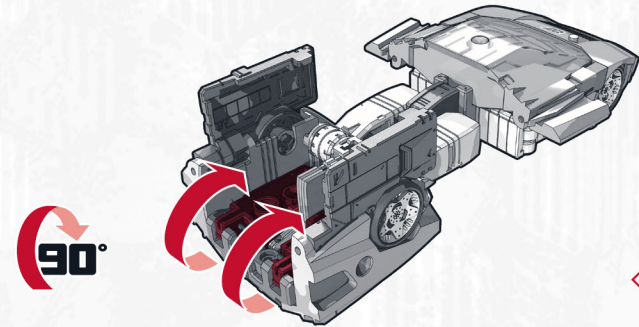

14

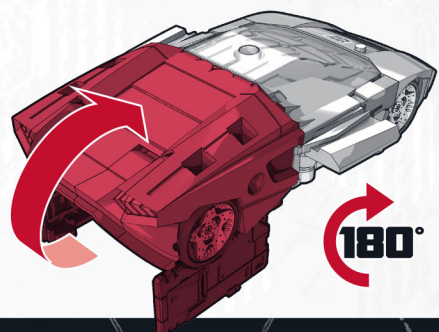

15

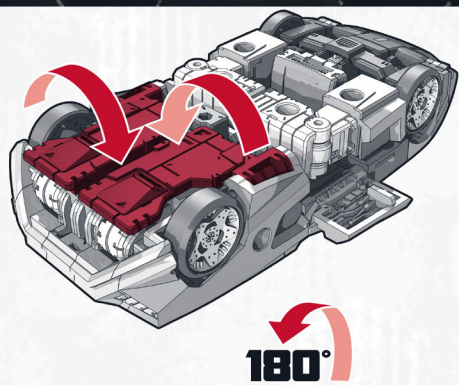

16

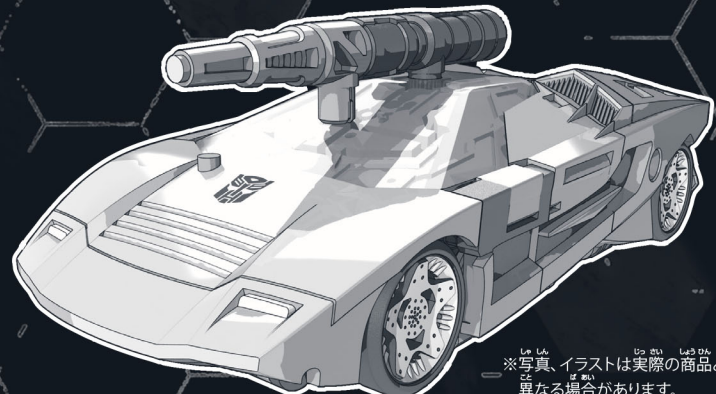
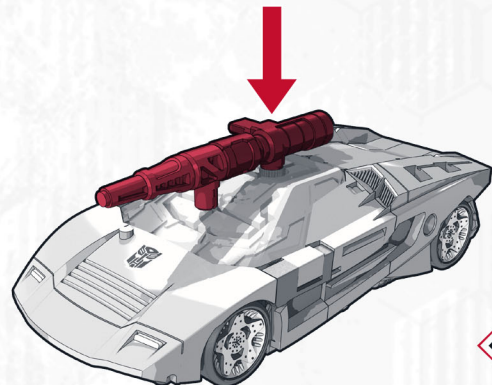
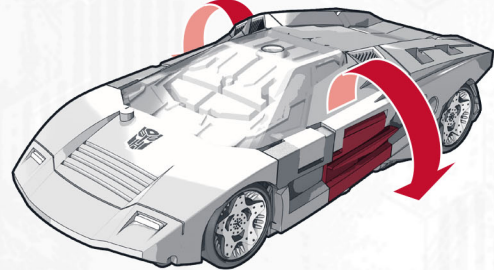

(en) Retain instructions for future reference. (fr) Conservez ces instructions pour référence ultérieure. (de) Bitte die Anleitung für spätere Rückfragen aufbewahren. (es) Conserve este instructivo para futuras referencias. (pt) Guardar instruções para eventuais consultas. (it) Conserva le istruzioni come futuro riferimento. (nl) Bewaar de gebruiksaanwijzing om later nog eens te lezen. (sv) Spara instruktionerna för att kunna hänvisa till dem i framtiden. (da) Gem vejledninger til fremtidig referencebrug. (no) Ta vare på disse instruksjonene for fremtidig referanse. (fi) Säilytä nämä tiedot tulevaa tarvetta varten. (el) Φυλάξτε τις οδηγίες για μελλοντική αναφορά. (pl) Zachowaj instrukcje na przyszłość. (hu) Őrizd meg a használati útmutatót. (il) Ileride basırmak üzere talimatları saklayın. (cs) Tyto informace uschovejte pro budoucí použití. (sk) Návod si odložte na použitie v budúcnosti. (ro) Păstrează instrucțiunile pentru a le consulta în viitor. (ru) Сохраните инструкции для будущего использования. (bg) Запазете инструкциите за бъдещи справки. (tr) Saklayın ve ilerde kullanmak için kullanın. (uk) Інструкції зберігайте для подальшого використання. (hr) Sačuvajte upute za buduću upotrebu. (lt) Instrukciją pasilikite ateičiai. (sl) Navodila shрани, mogoče jih boš še potreboval. (mk) Збережіть інструкції за подальшоу употребу. (sr) Sačuvajte upute za buduću upotrebu. (pt-br) Salve as instruções para futuras referências. (tr) Saklayın ve ilerde kullanmak için kullanın. (ru) Сохраните инструкции для будущего использования. (bg) Запазете инструкциите за бъдещи справки. (tr) Saklayın ve ilerde kullanmak için kullanın. (uk) Інструкції зберігайте для подальшого використання. (hr) Sačuvajte upute za buduću upotrebu. (lt) Instrukciją pasilikite ateičiai. (sl) Navodila shрани, mogoče jih boš še potreboval. (mk) Збережіть інструкції за подальшоу употребу. (sr) Sačuvajte upute za buduću upotrebu. (pt-br) Salve as instruções para futuras referências.

(en) احتفظ بالتعليمات للرجوع اليها في المستقبل. (fr) Conservez ces instructions pour référence ultérieure.

Manufactured under license from TOMY Company, Ltd. TRANSFORMERS and HASBRO and all related trademarks and logos are trademarks of Hasbro, Inc. © 2020 Hasbro, Pawtucket, RI 02861-1059 USA. HASBRO CANADA, LONGUEUIL, QC, CANADA J4G 1G2. US/CANADA TEL. 1-800-255-5516. Centro de Servicio para México: TEL. 5876-2998 y para el interior de la República TEL. 01-800-7-12-62-25. centrodeserviciomexico@hasbro.com. Manufactured by/Produced by: Hasbro SA, Rue Emile-Boéchat 31, 2800 Delémont CH. Represented by/Reprezentat de: Hasbro, De Entree 240, 1101 EE Amsterdam, NL. © Üretici Firma Bilgileri: Hasbro SA, Rue Emile-Boéchat 31, 2800 Delémont İsviçre TEL +41 324210800. Hasbro Oyuncak San. ve Tic. A.Ş. tarafından ithal edilmiştir. Tüketici Hizmetleri: Burhaniye Mah. Abdullahağa Cad. No: 51/2 34676 Beylerbeyi İstanbul Türkiye TEL +90 2164229010.

※写真、イラストは実際の商品と異なる場合があります。

E9505/E9489 Asst. PN00046798

