

# TRANSFORMERS

AGE OF THE PRIMES

## 取扱説明書

※本書をご確認後は、必ず  
保管しておいてください。

対象年齢15才以上

大人向け商品です。玩具ではありません。

AOTP-16  
マイクロナプライム



G1029/G0474 Asst. PN00094239

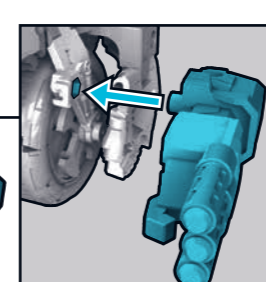
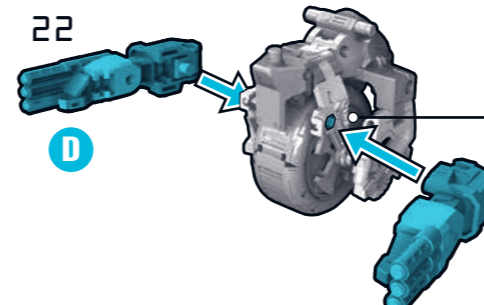
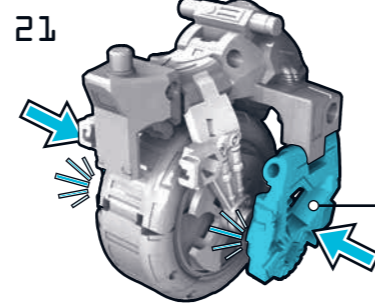
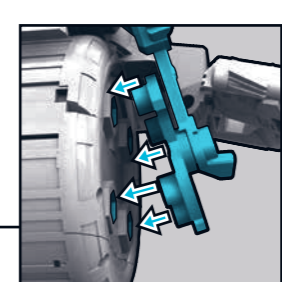
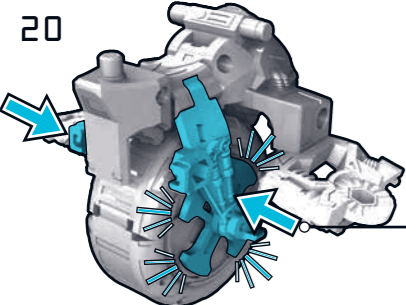
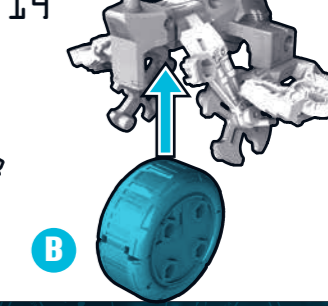
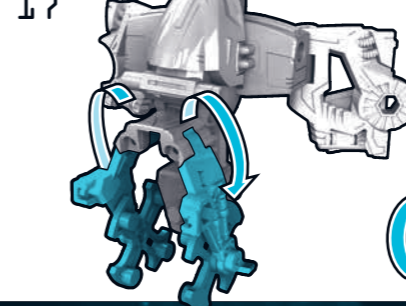
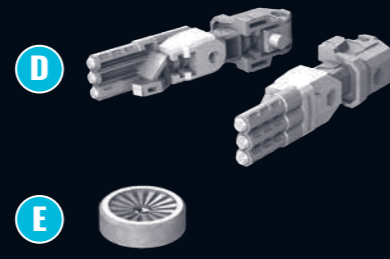
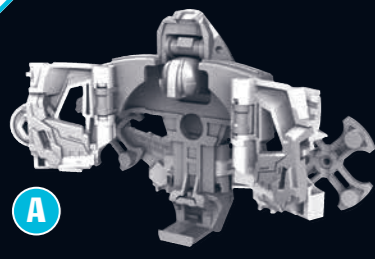
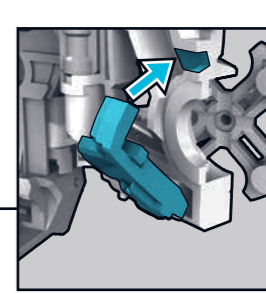
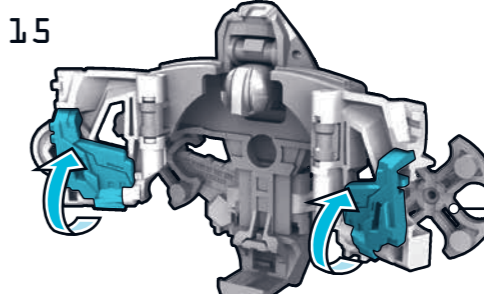
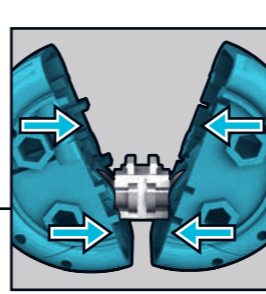
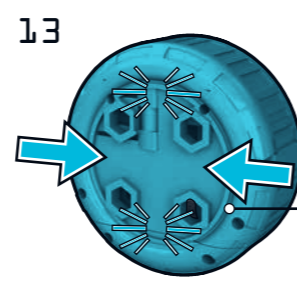
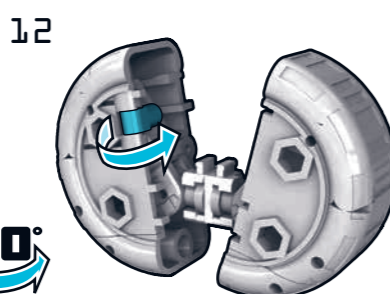
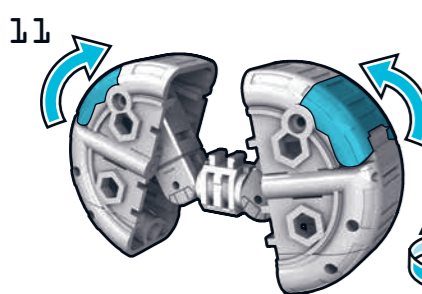
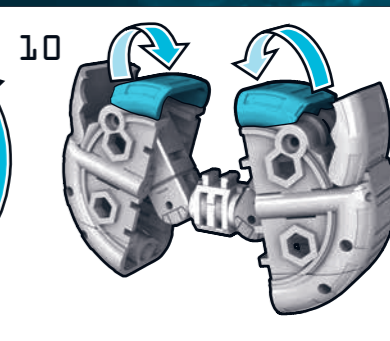
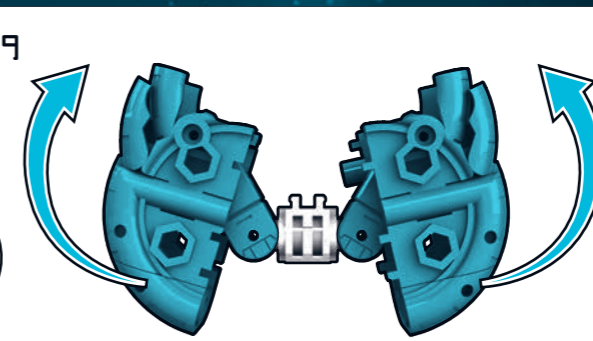
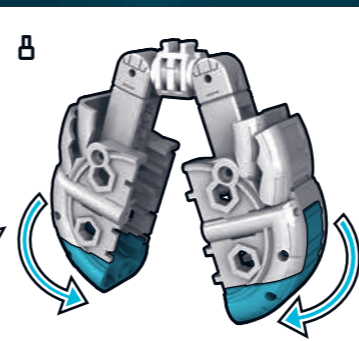
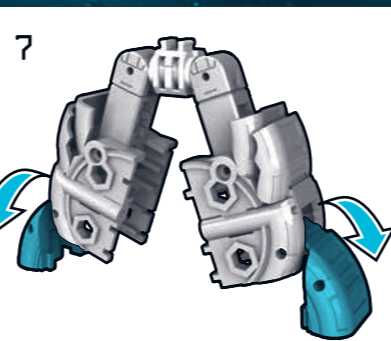
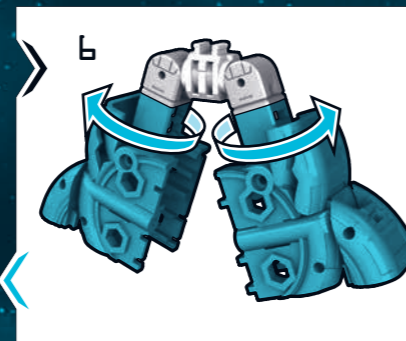
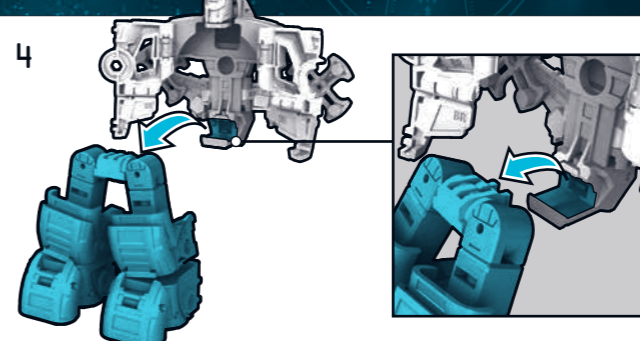
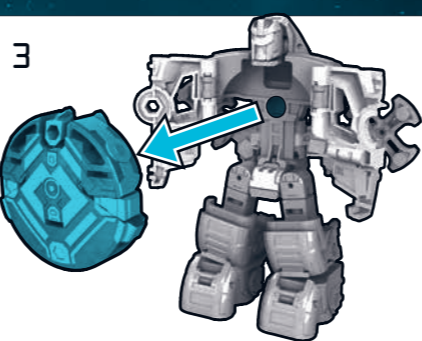
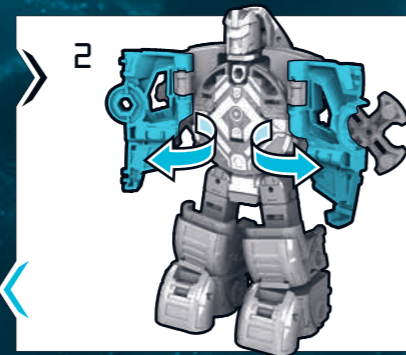
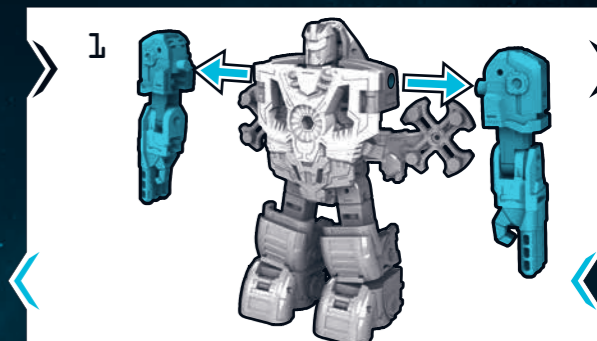
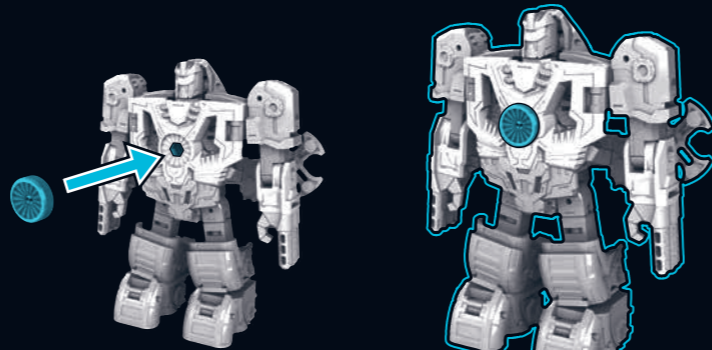

180°



C

